

MONTAGE- UND BEDIENUNGSANLEITUNG ASSEMBLY AND OPERATING MANUAL INSTRUCTIONS DE MONTAGE ET D'UTILISATION

72

Vorratssteckregal VSR 3000
Storage shelving unit VSR 3000
Rayonnage à système enfichable VSR 3000

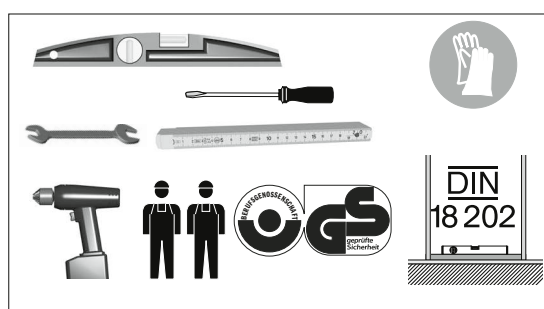

SSI SCHÄFER

1.0 WARNHINWEISE

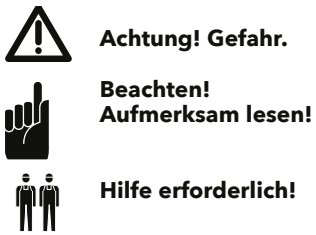

1.0 WARNING NOTES

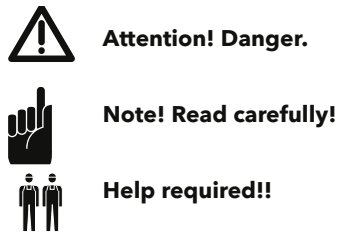

1.0 AVERTISSEMENTS



2.0 SICHERHEITSHINWEISE / SAFETY MEASURES / CONSIGNES DE SÉCURITÉ



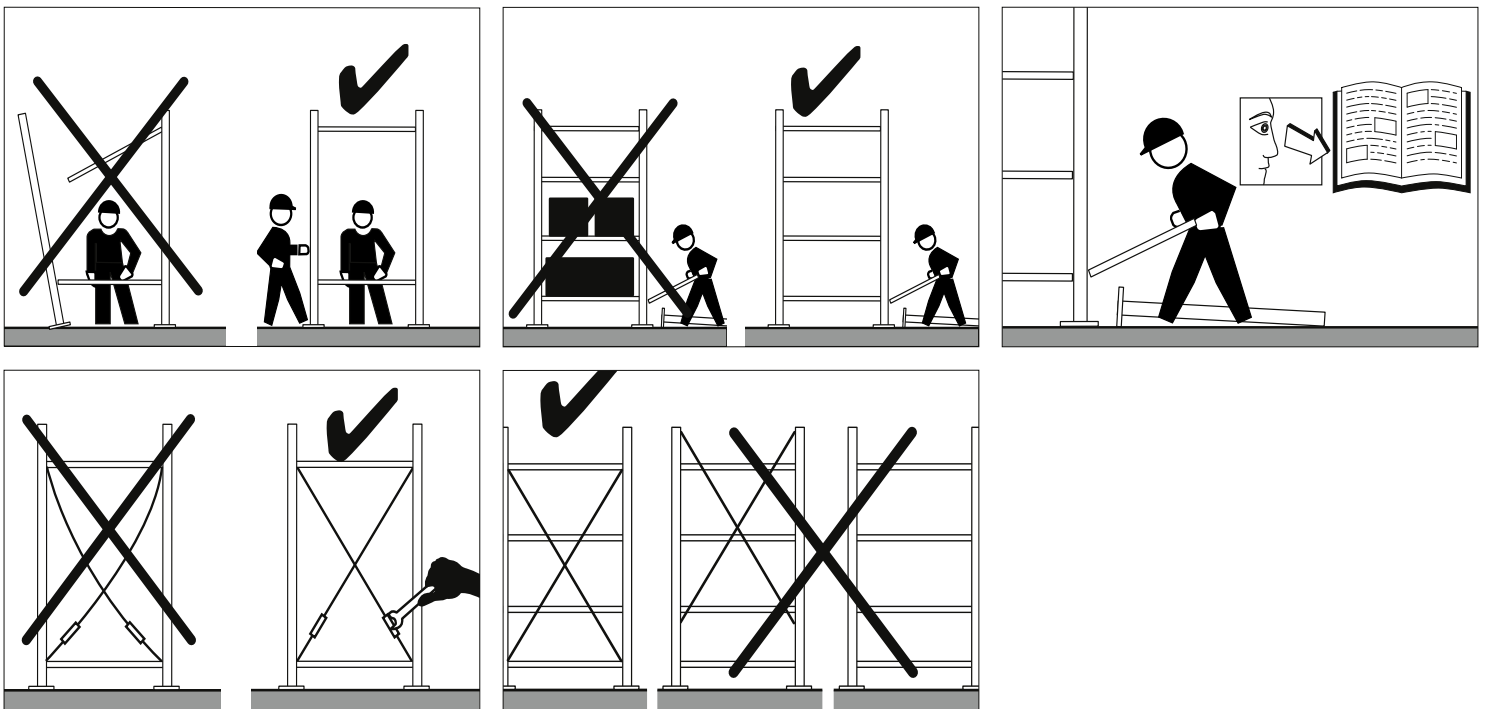



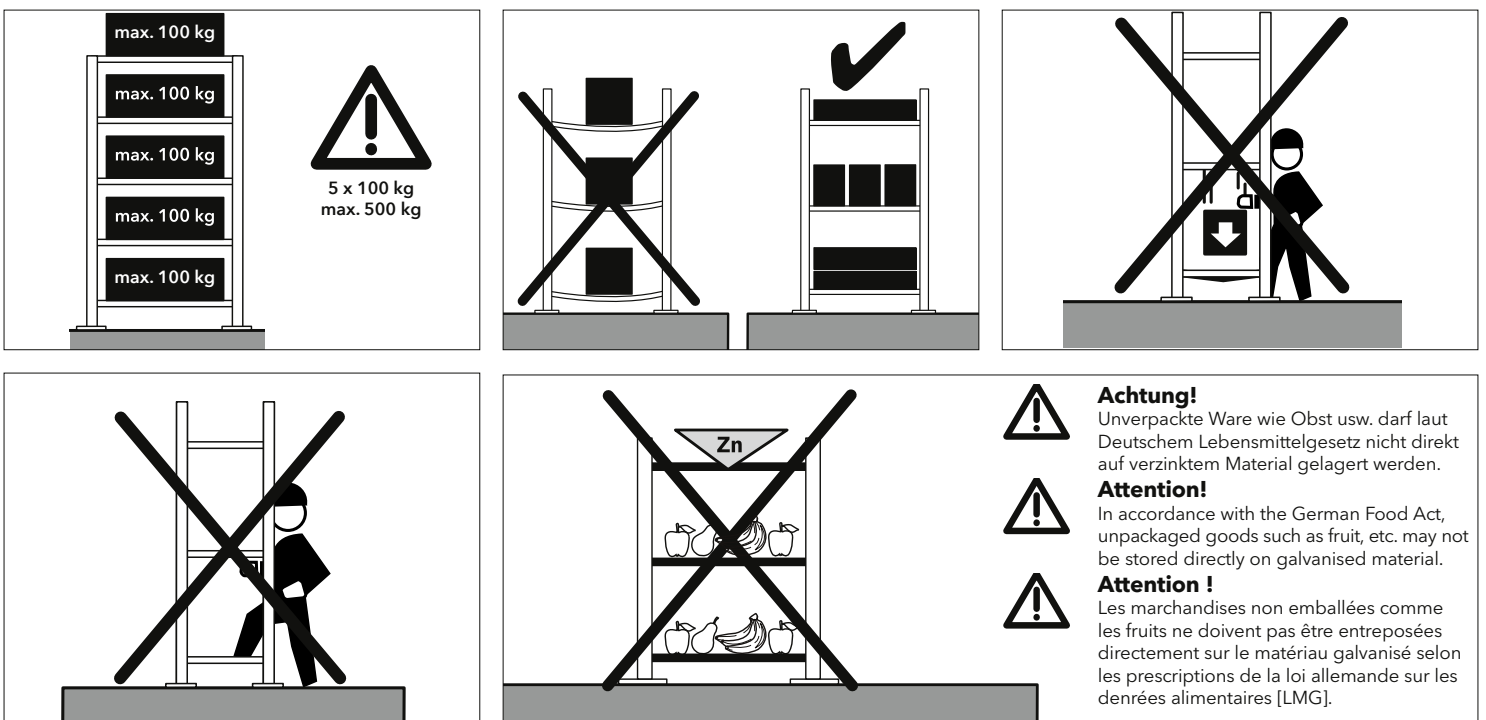





2.1 REGALAUFBAU / ASSEMBLY OF THE SHELVING UNITS / MONTAGE D'UNE TRAVÉE DE RAYONNAGE



2.2 BEDIEN- UND NUTZUNGSHINWEISE / MAINTENANCE AND USER GUIDELINES / CONSEILS D'UTILISATION ET DE MANIPULATION

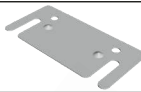

3.0 STÜCKLISTE GRUNDFELD / PART LIST STARTER UNIT / LISTE DES PIÈCES TRAVÉE DE BASE

Bezeichnung / Designation / Désignation		Anzahl Number Quantité	Darstellung / Illustration / Représentation	Bezeichnung / Designation / Désignation		Anzahl Number Quantité	Darstellung / Illustration / Représentation
1	Regalständer kurz Short upright Montant version courte	4x		2	Regalständer lang Long upright Montant version longue	4x	
3	Schottsteg Frame brace Entretoise	4x		4	Fachboden Shelf Étagère	5x	
5	Verbinder Connector Connecteur	4x		6	ST 4,8x16 DIN EN ISO 7049	16x	
7	Fußplatte Footplate Platine	4 x		8	ST 4,8x19 DIN EN ISO 7049	4x	
9	Unterlegplatten (optional) Shims (optional) Cales (facultatif)	4 x		10	Abschlusskappe Top cap Capuchon d' extrémité	4x	
11	Kreuzverband Cross braces Croisillon	1 x			Schraubanker HUS3-H6x60 (optional) Screw anchor (optional) Ancrage à vis (facultatif)	4x	

3.1 STÜCKLISTE ANBAUFELD / PART LIST EXTENSION UNIT / LISTE DES PIÈCE TRAVÉE COMPLÉMENTAIRE

Bezeichnung / Designation / Désignation		Anzahl Number Quantité	Darstellung / Illustration / Représentation	Bezeichnung / Designation / Désignation		Anzahl Number Quantité	Darstellung / Illustration / Représentation
1	Regalständer kurz Short upright Montant version courte	2x		2	Regalständer lang Long upright Montant version longue	2x	
3	Schottsteg Frame brace Entretoise	2x		4	Fachboden Shelf Étagère	5x	
5	Verbinder Connector Connecteur	2x		6	ST 4,8x16 DIN EN ISO 7049	8x	
7	Fußplatte Footplate Platine	2x		8	ST 4,8x19 DIN EN ISO 7049	2x	
9	Unterlegplatten (optional) Shims (optional) Cales (facultatif)	2x		10	Abschlusskappe Top cap Capuchon d' extrémité	2x	
					Schraubanker HUS3-H6x60 (optional) Screw anchor (optional) Ancrage à vis (facultatif)	2x	

**Grundfeld / Starter unit
Travée de base**



Grundfeld
5 Fachböden
2 Regalrahmen
Kreuzverband

Basic field
5 shelves
2 shelf frames
Cross braces

Travée de base
5 étagères
2 échelles croisillon

Anbaufeld
5 Fachböden
1 Regalrahmen

Extension unit
5 shelves
1 shelf frames

**Travée complémen-
taire**
5 étagères
1 échelles

**Anbaufeld / Extension unit
Travée complémentaire**

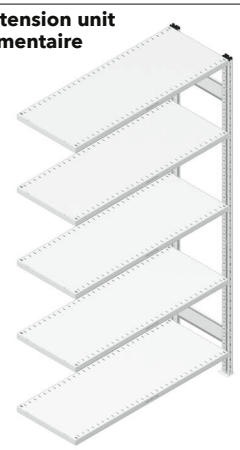

4.0 MONTAGE REGALRAHMEN / ASSEMBLY OF THE UPRIGHT FRAMES / MONTAGE DES ÉCHELLES

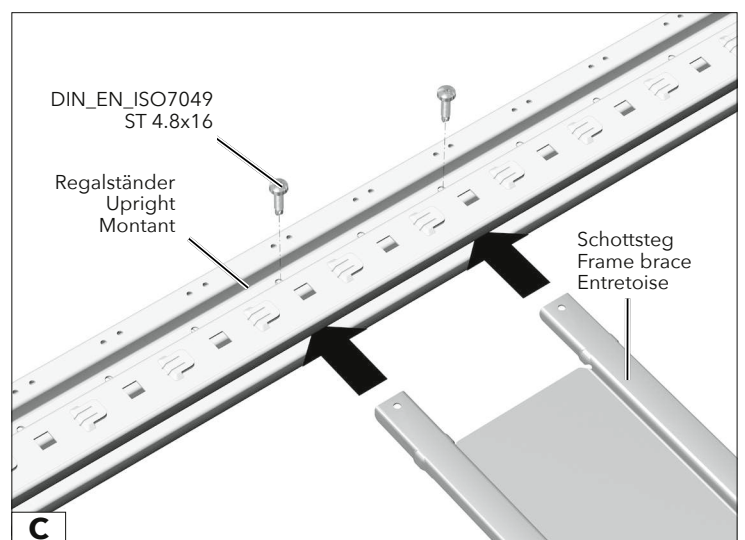
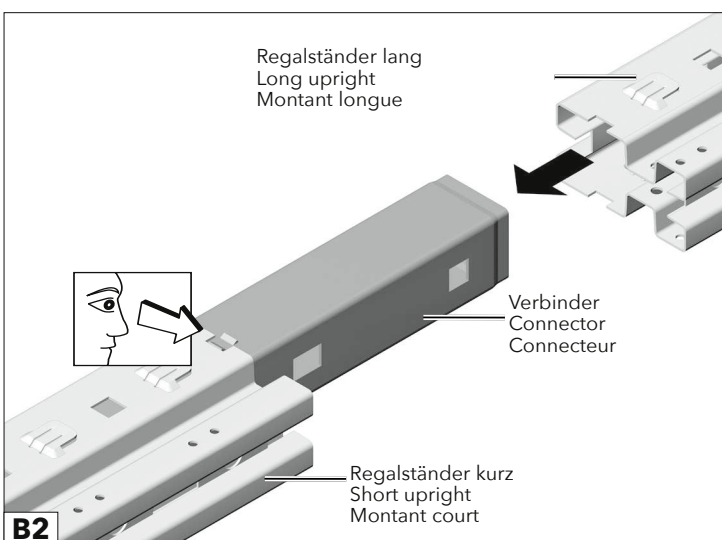
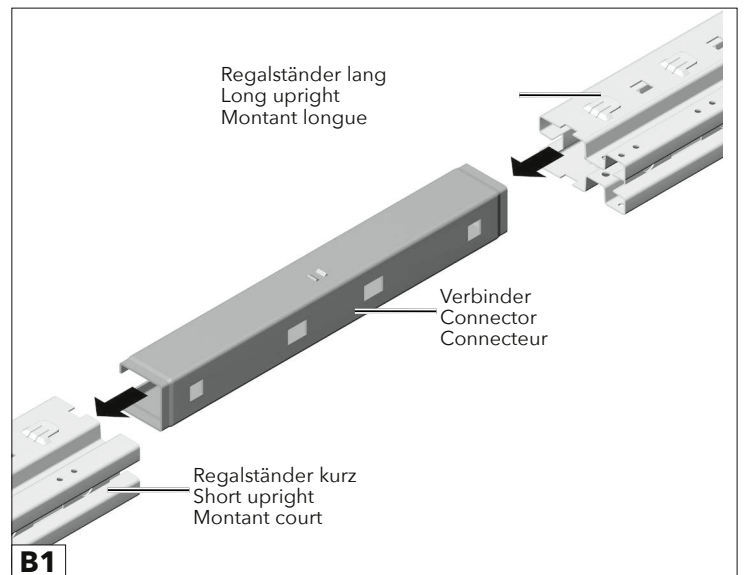
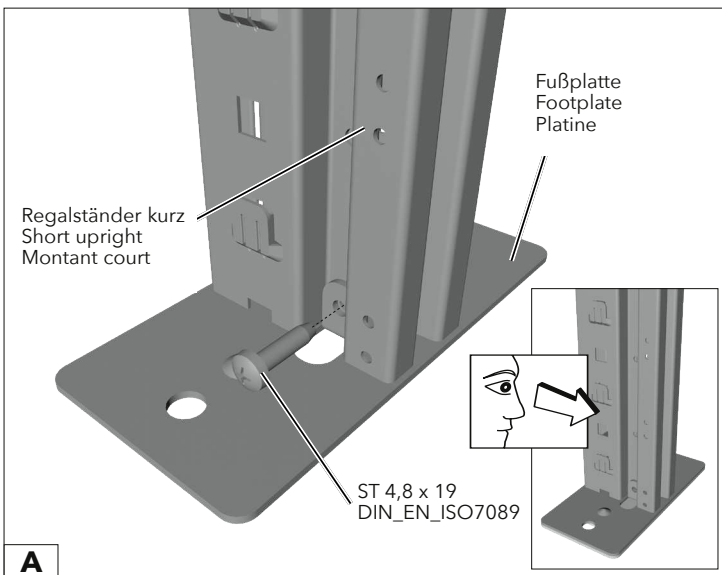
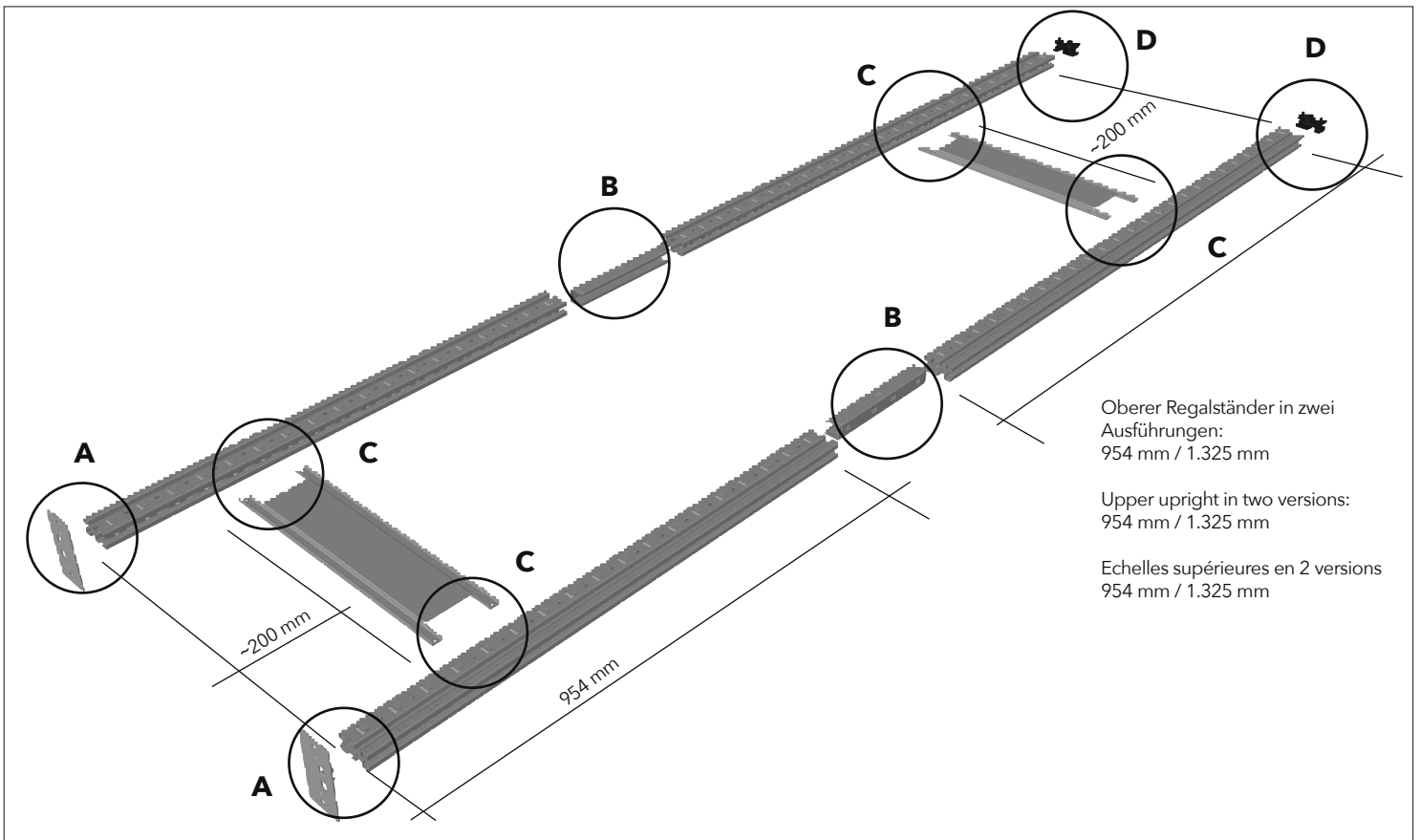

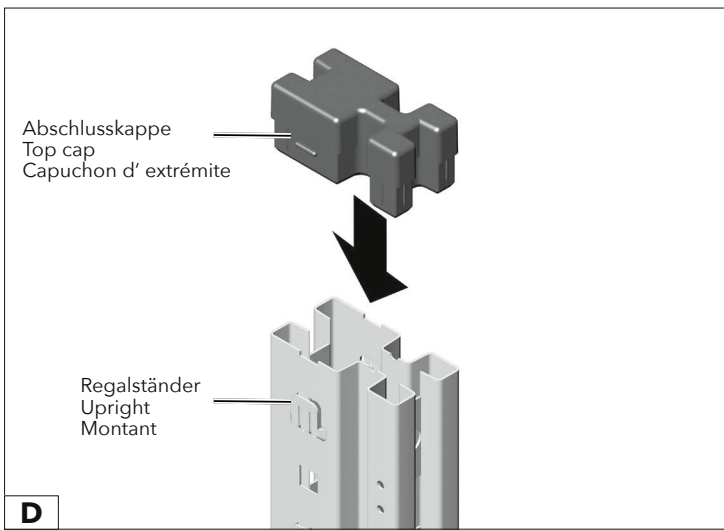

5.0 MONTAGE UND AUSRICHTEN / ASSEMBLY AND ALIGNMENT / MONTAGE ET ALIGNEMENT

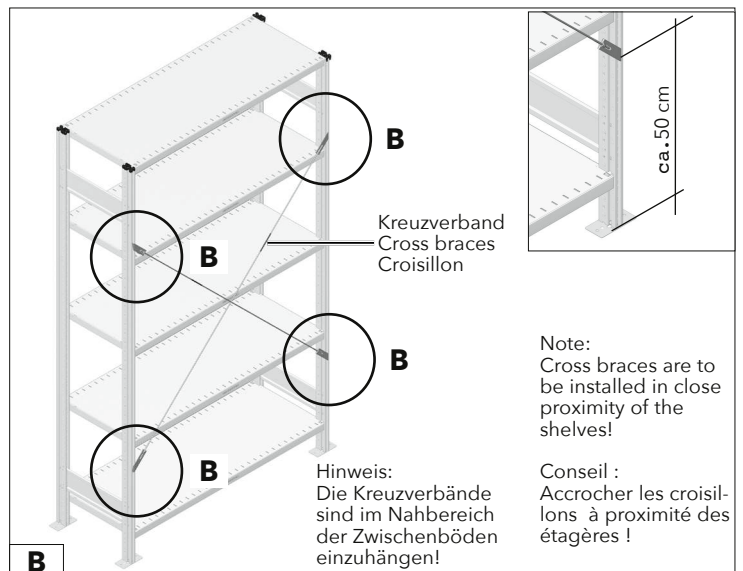
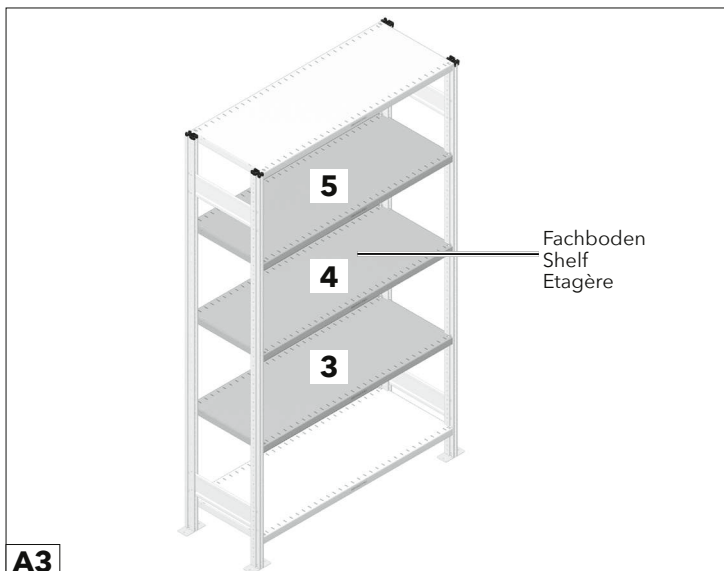
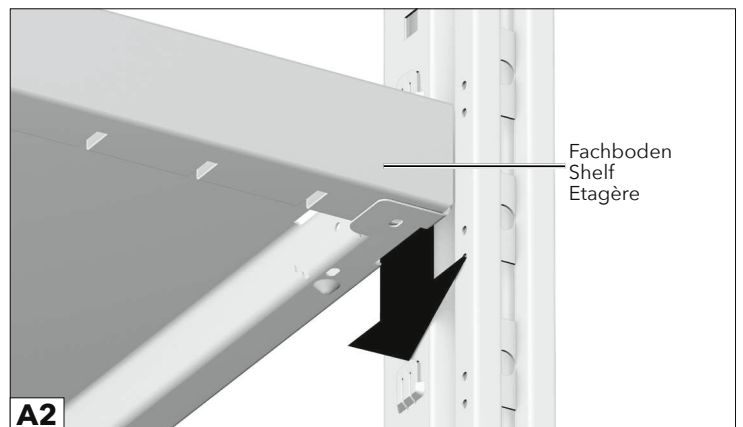
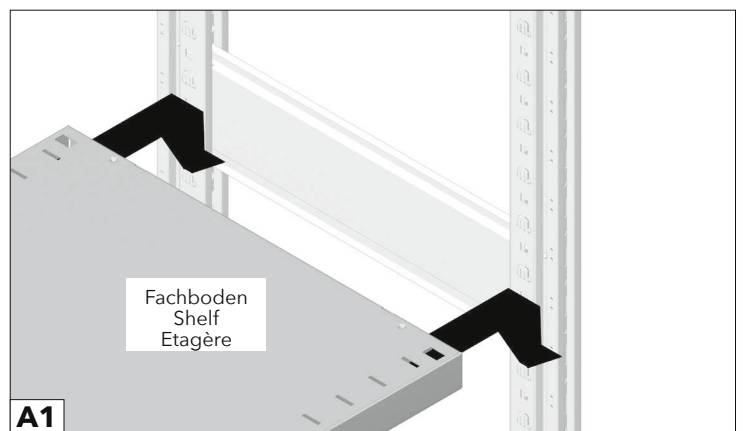
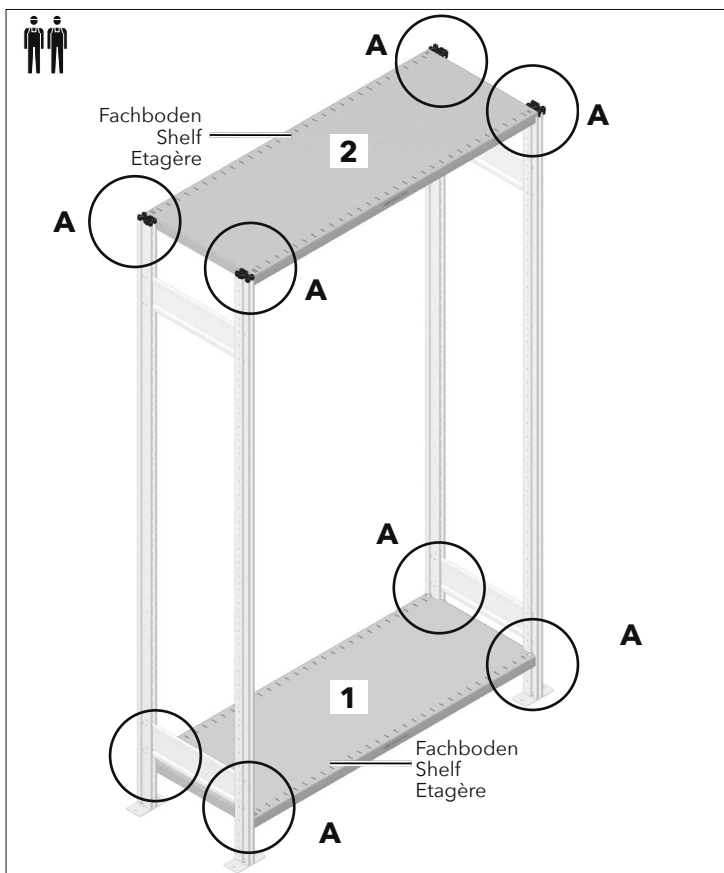

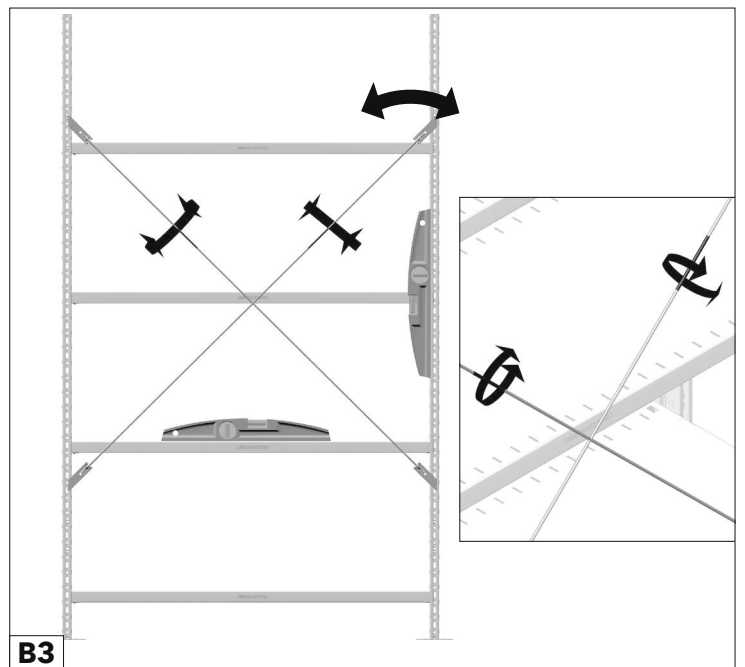
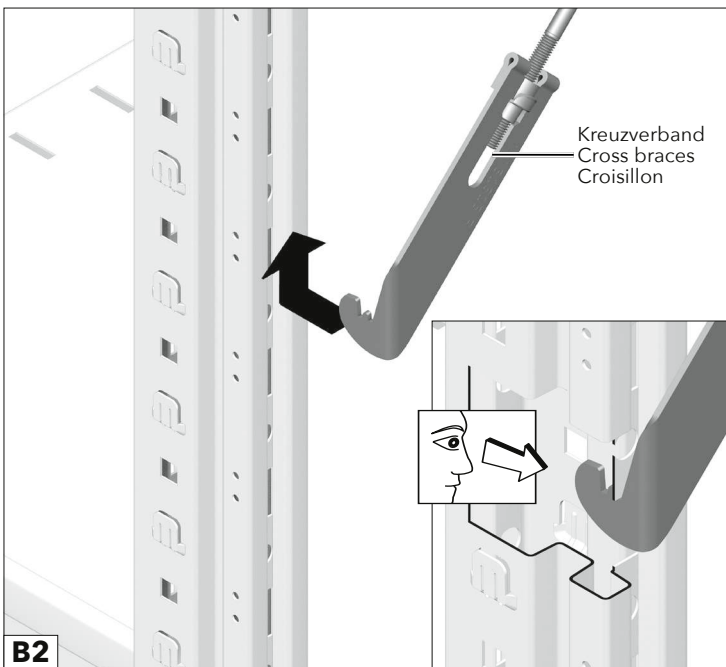

6.0 BODENBEFESTIGUNG VON REGALSTÄNDER/ FLOOR ANCHORING / FIXATION AU SOL

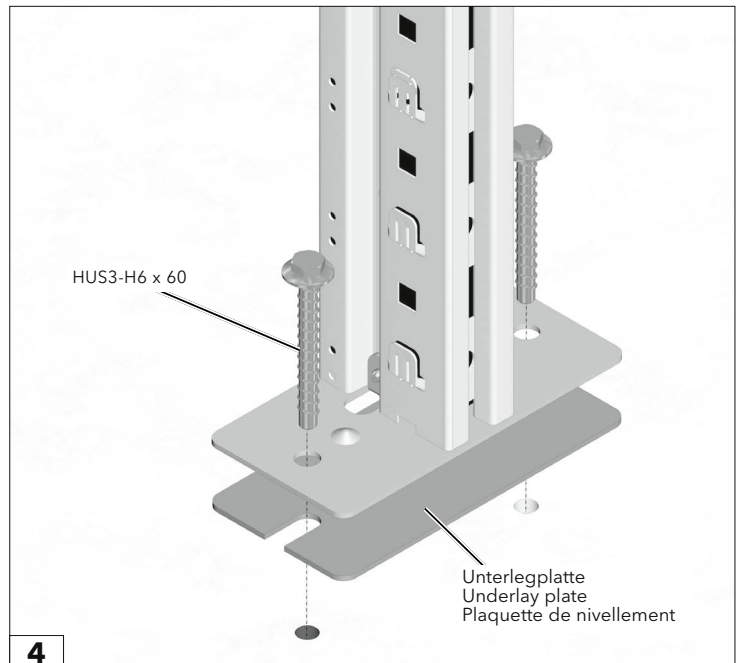
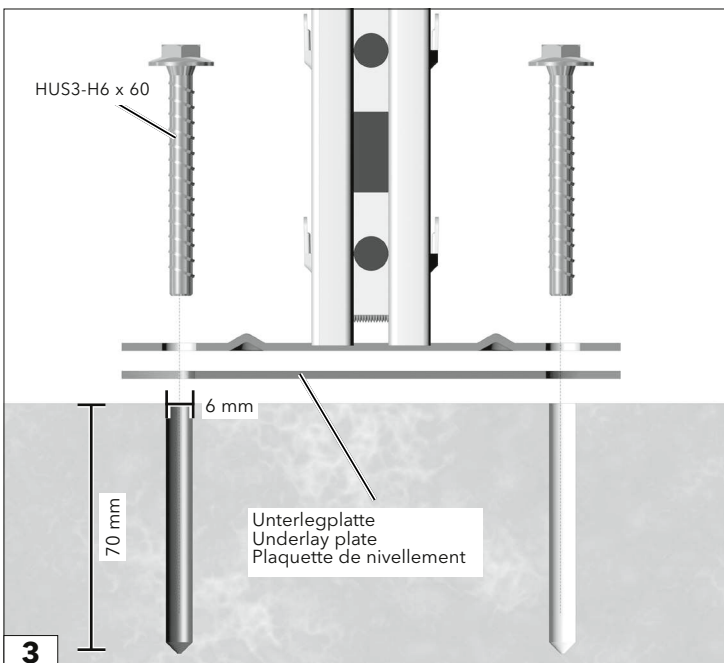
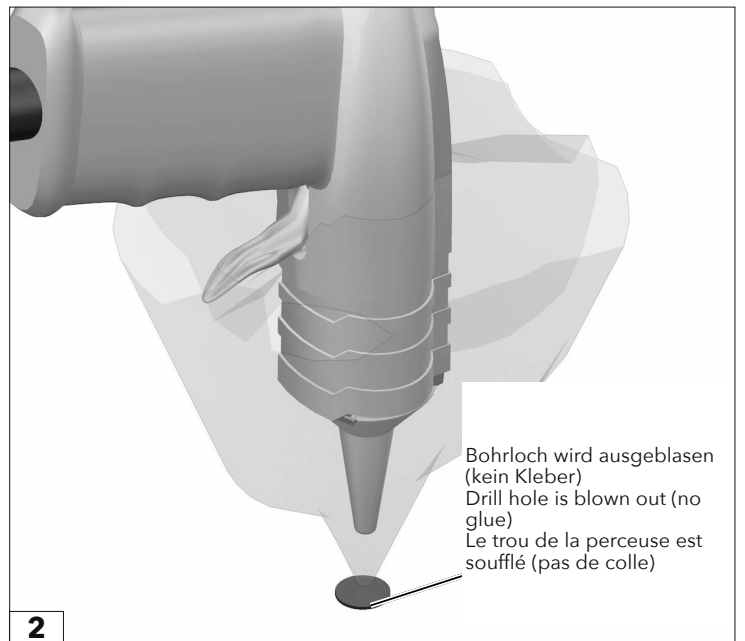
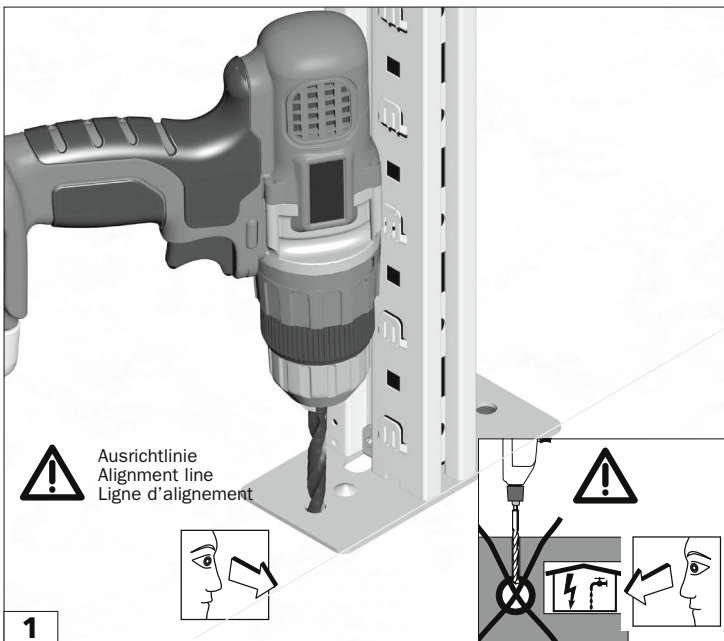

7. BODENBEFESTIGUNG VON REGALSTÄNDER / FLOOR ANCHORING / ANCRAGE MÉNAIQUE

Einfachzeile / Single row / Rangée de rayonnage simple-face

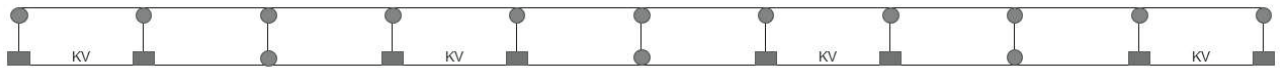

Doppelzeile (Rahmendistanz bis 6mm) / Double row (frame distance up to 6 mm) / Rangée de rayonnage double-face (distance entre échelles jusqu'à 6 mm)

KV innen / Cross bracing internal / Croisillon intérieur

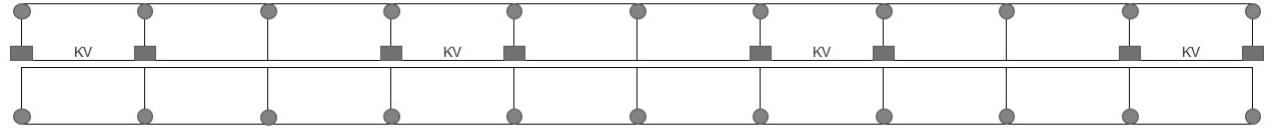

KV außen / Cross bracing external / Croisillon extérieur

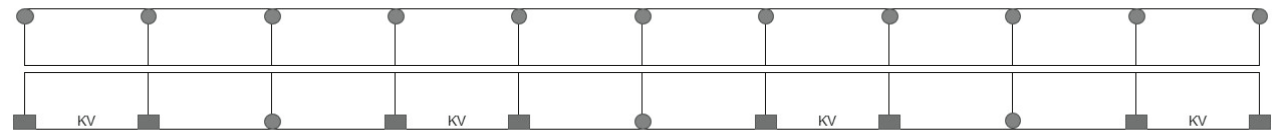

Doppelzeile (Rahmendistanz größer 6mm) / Double row (frame distance higher than 6 mm) / Rangée de rayonnage double-face (distance entre échelles supérieure à 6 mm)

KV außen / Cross bracing external / Croisillon extérieur

