

SSI LOGIMAT® VERTICAL LIFT MODULE

The Dynamic Solution for the Storage
and Picking of Small Parts

ssi-schaefer.com



SSI SCHAEFER



RUNNING OUT OF SPACE OR STRUGGLING WITH PICK RATES?

The SSI LOGIMAT® Vertical Lift Module (VLM) from SSI SCHAEFER is the solution for these challenges and more.

The SSI LOGIMAT® Vertical Lift Module is similar to an oversized drawer cabinet with two stacks of trays, one at the front and one at the back. Between the two rows of trays is a lift. This lift climbs the entire height of the vertical storage machine to remove an individual tray from the respective positions and to deliver them to the access opening.

The unit has an opening at the front and allows users to select a specific tray via a user interface. The unit sends

the tray down to the opening and enables the user to pick their item safely and securely. VLMs save an enormous amount of space, which means items take minimal square footage since everything is stored vertically.

Users incorporate VLMs for various applications to everything from nuts and bolts to high value items or pharmaceuticals. In addition, many VLMs come with options that make picking virtually error-free and provide ergonomic benefits to increase picking speeds.

SSI LOGIMAT® IS THE ALL-IN-ONE STORING AND PICKING SOLUTION



SSI LOGIMAT® VLM HIGHLIGHTS

- Highly convenient goods-to-person principle
- Compact design has economical and environmental advantages
- Highest storage density for small parts, up to 90% less floor space
- Automated processes and ergonomic design improve performance by over 20%
- Simple user guidance with minimal training requirements for operation
- Increased performance through automated processes and greater ergonomics



Space optimization

Utilize ceiling height, save space without cost-intensive structural expansion creates maximum storage space compression



More picking safety

Reduce costs through error-free picking with the assistance of innovative machine functionalities



Higher picking efficiency

Goods-to-person principle creates short distances and increases picking performance



More efficient through cleanliness and tidiness

Reduction of search and transport times, higher work safety, protection of sensitive stored goods inventory differences and incorrect stock values



Safety through ergonomics

Individual working heights and safety systems reduce absences due to illness and increase employee satisfaction

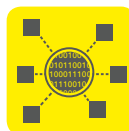

Digitalization creates transparent processes

Quick overview, inventory security and traceability of stock simplify inventory and improve warehouse processes in a sustainable way

UNLIMITED COMBINATION POSSIBILITIES

The SSI LOGIMAT® dynamic system is a future-proof logistical solution.

The path to automation with SSI LOGIMAT® and WEASEL®

The plastic electroplating specialist C+C Krug GmbH took the path to semi-automation of logistics processes together with SSI SCHAEFER. Three SSI LOGIMAT® Vertical Lift Modules, two automated guided vehicles, type WEASEL® and a short bin conveying system ensure efficient processes between warehouse and production.



Even greater efficiency thanks to conveying systems

Integrating the SSI LOGIMAT® into ergonomically designed conveying systems is an effective measure for realizing efficient material flow within a facility. The conveying system connects the individual warehouse areas or work stations together. This allows the employees to focus entirely on the picking of goods on the SSI LOGIMAT®.



Intelligent installation

The SSI LOGIMAT® can also be attached to the outer facade of the warehouse building, if necessary. An installation like this can minimize the construction costs of expanding the warehouse because only the cut-out for the operating opening needs to be taken into consideration in the existing building wall. In addition, the Vertical Lift Module allows for independent planning of the system height. Several SSI LOGIMAT®s can be used for the picking and storage of items, allowing other warehouse areas to be connected.



SMART USE OF WAREHOUSE SPACE WITH LMB CONTAINER

The LMB container series has been specially designed for use in storage lifts. The containers have been optimized as partition to the tray depth of 800 mm and can also be individually subdivided with partition walls. This enables a fast and simple alignment to your stored goods.

YOUR BENEFITS

- Maximize space with the maximum utilization of tray depth
- No mixing with other products
- Available height: 95 and 195 mm
- Available width: 100, 200, 400 mm
- Ergonomic access from above
- Light and solid PP material
- Easily integrated into other storage lifts
- Easy to clean

ADVANTAGES OF LMB CONTAINERS WITH DIVIDERS

- Easy snap in system, very comfortable putting in the divider
- No mixing of your products, they stay safe in their compartments
- Each LMB can take in its lengths of 800 mm
- Six dividers, in a grid of approx. 100 mm = up to max. seven compartments
- Angled surfaces for stickers
- Much more silent and lighter compared with conventional dividers from metal

Container variation

Mix and vary **all five different sized LMB containers** in the storage lift as needed in your specific application



Up to 280 locations possible in one tray



All LMB types are delivered with two dividers



External dimensions (L x W x H)	Internal dimensions (L x W x H)	Capacity	Divides into max.
800 x 100 x 95 mm	774 x 74 x 93 mm	5.2 Litres	
800 x 200 x 95 mm	774 x 174 x 93 mm	12.4 Litres	
800 x 200 x 195 mm	774 x 174 x 193 mm	25.7 Litres	7 compartments
800 x 400 x 95 mm	774 x 374 x 93 mm	26.7 Litres	
800 x 400 x 195 mm	774 x 374 x 193 mm	55.5 Litres	

HARDWARE OPTIONS



LogiTilt

The **LogiTilt** is an incline option that enables the ergonomic removal of goods from the tray. This option reduces the removal depth. The tilt angle is individually adjustable for each tray - from 10 to 30 degrees, in one degree intervals.



LogiBar

Continuous confirmation light barrier under the operating opening for optimizing the picking performance.

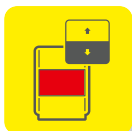

LogiGate

LogiGate is a hub gate that separates the elevator travel shaft and the access opening. The hub gate consists of two parts. The two pieces connect via a chain, and the lower half of the gate acts as a counterweight. This function halves the cycle times and saves energy.



LogiDrive

LogiDrive is an automatic feature where the tray extends outwards towards the individual. The roller tracks allow for a smooth and quiet operation. This ergonomic feature is great for heavy goods handled with a crane, for example.

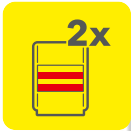

LogiDual

Parallel, time-delayed tray movements for improved performance. While removing goods from the first tray, the next tray is already moving to the operating opening.



LogiPull

The **LogiPull** is a manual, full pull out tray function with two foldout tray mounts. These mounts fit onto the racking up-rights, but fixation to the floor is not necessary. The access opening and the folding handles fit with the roller tracks, which minimizes the manual force of the tray extension.

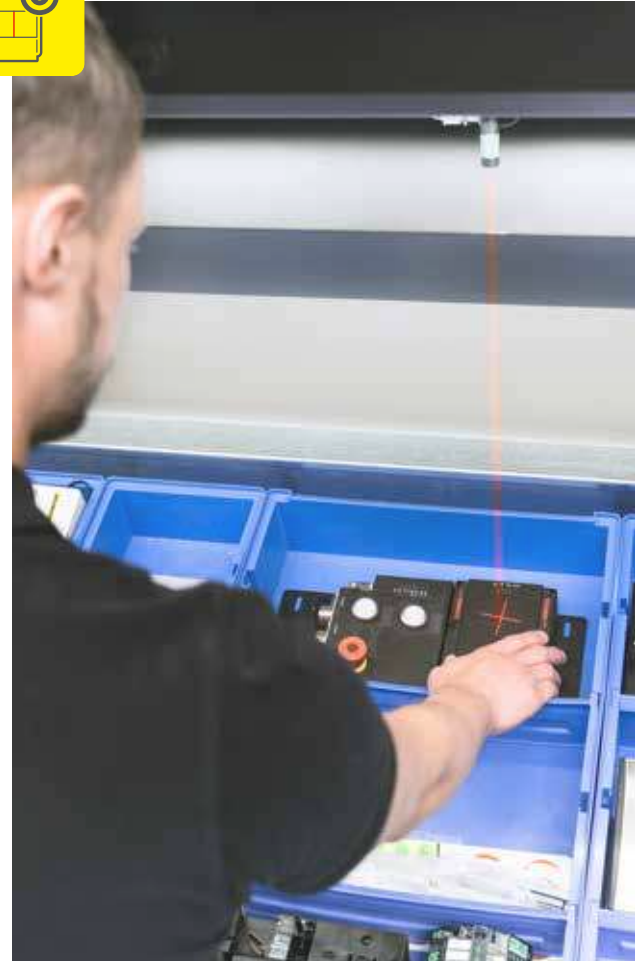
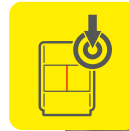

LogiPointer

Reduce picking errors by utilizing the **LogiPointer** option for SSI LOGIMAT®. An optical indication of the correct storage position is visible via a laser pointer.



TECHNICAL FEATURES



1. Heights measurement light grid
2. Stable frame construction
3. Flexible tray concept
4. Variable sheet metal cladding
5. Ergonomic operating opening
6. Intuitive touch screen
7. Aluminum corner profiles
8. Double sided shaft monitoring
9. Safety light grid

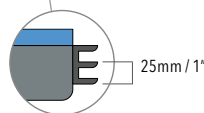

Minimum height	Maximum height	Tray load capacity	Machine load capacity
2,450 mm	up to 23,850 mm in 100 mm increments	up to 700 kg	up to 80 tons

Usable tray dimensions (mm)	Width (A) incl. paneling (mm)	Depth (B) incl. paneling (mm)
1,825 x 625	2,370	2,712
1,825 x 815	2,370	3,092
1,825 x 1,323	2,370	4,616
2,025 x 625	2,570	2,712
2,025 x 815	2,570	3,092
2,025 x 1,323	2,570	4,616
2,425 x 625	2,970	2,712
2,425 x 815	2,970	3,092
2,425 x 1,323	2,970	4,616
2,825 x 625	3,370	2,712
2,825 x 815	3,370	3,092
2,825 x 1,323	3,370	4,616
3,025 x 625	3,570	2,712
3,025 x 815	3,570	3,092
3,025 x 1,323	3,570	4,616
3,225 x 625	3,770	2,712
3,225 x 815	3,770	3,092
3,225 x 1,323	3,770	4,616
3,625 x 625	4,170	2,712
3,625 x 815	4,170	3,092
3,625 x 1,323	4,170	4,616
4,025 x 625	4,570	2,712
4,025 x 815	4,570	3,092
4,025 x 1,323	4,570	4,616

Height-adjustable tray in 25 mm / 1" increments



Standard paneling colors

RAL 5014 (Pigeon blue)	RAL 9010 (Pure white)	RAL 7024 (Graphite gray)	RAL 7035 (Light gray)

Other colors available on request. Color deviations may occur due to monitor or printer settings.

Power supply

Lenze asynchronous motor with 4 KW up to 11 KW depending on the drive chosen. There are four different drives to choose from:

- Standard
- LogiHeavy
- LogiPower
- LogiFast

Technical data

Power supply	480 V +/- 10% 60Hz, 3I/ PE
Electrical protection	25 A - 40 A
Max. power	12kva - 21kva
Control voltage	24VDC

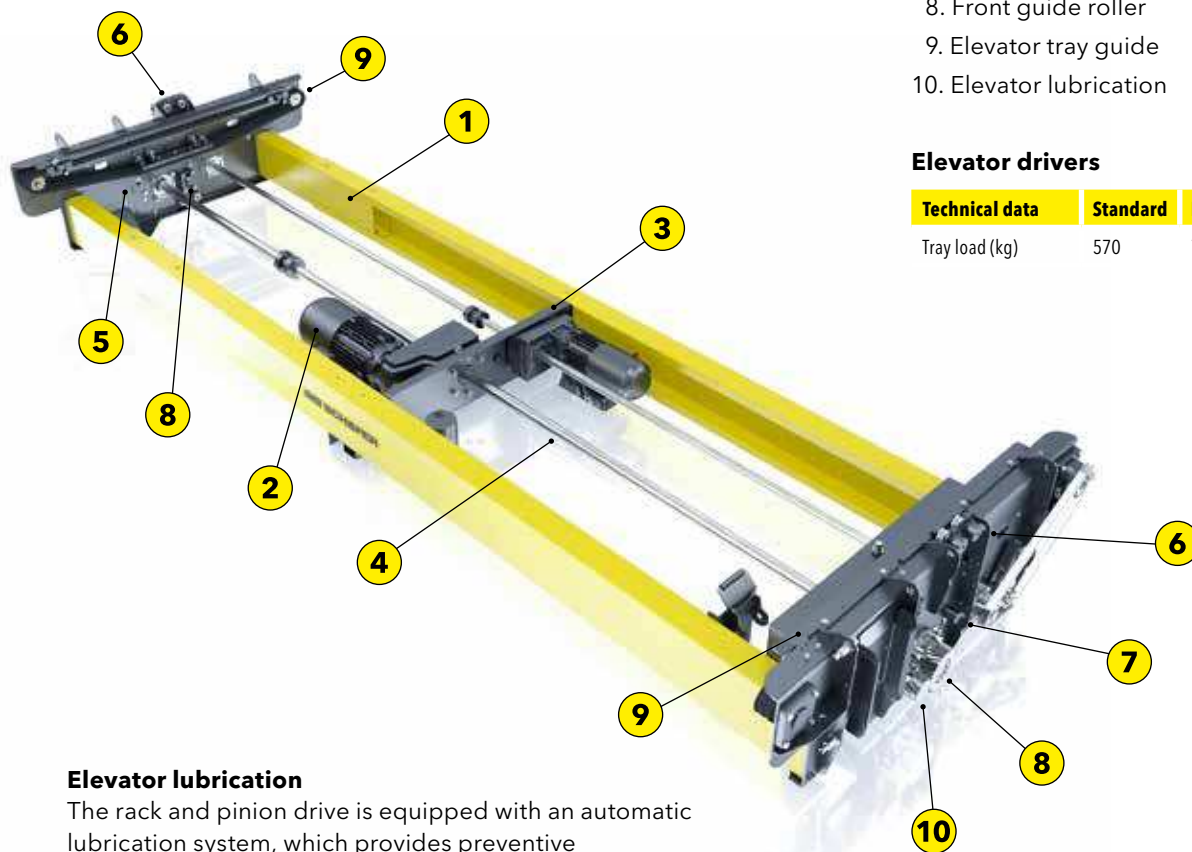

Elevator lubrication

The rack and pinion drive is equipped with an automatic lubrication system, which provides preventive maintenance every time the elevator moves.

Elevator parts

The elevator is moved by a flat geared motor, which transfers the force directly to the shaft and pinion onto the gear rack. Two different gear drives are used to form variants for a solid performance every time a user selects a tray.

1. Telescopic crossbeams
2. Elevator motor
3. Motor carrier
4. Elevator shaft
5. Flange-bearing elevator
6. Elevator guide mechanism
7. Locking pin
8. Front guide roller
9. Elevator tray guide
10. Elevator lubrication

Elevator drivers

Technical data	Standard	Heavy	Power	Fast
Tray load (kg)	570	700	320	700



ADVANTAGES

- Maximum availability due to robust technology
- Minimal maintenance due to automatic lubrication
- High positioning accuracy without sensor technology that is susceptible to faults

SOFTWARE

From simple applications to complex warehouse management, SSI LOGIMAT® is a technology solution for your application.

The Vertical Lift Module from SSI SCHAEFER can be operated as an autonomous system or connected to a higher-level system. In recent years, the in-house software WAMAS® LOGIMAT has established itself as the No. 1 solution for SSI LOGIMAT®.

With modern item management and order management, it is perfectly matched to the functions of our machine. We also offer a fully integrated & certified SAP Solution. Furthermore SSI LOGIMAT® Vertical Lifts are compatible with 3rd Party Software.

INTEGRATED STANDARD CONTROL

Organization, control and security.

The SSI LOGIMAT® warehouse lift from SSI SCHAEFER is equipped with a programmable logic controller (PLC), which represents the first step into IT-supported warehouse management. This is operated with a graphical user interface. The programmable logic controller (PLC) allows users to easily access inventory and access trays where picking is made possible via virtual network computing (VNC).

The VNC represents the first step in computer-aided warehouse management. Users access via an easy-to-use interface and communication happens in realtime. The standard PLC controls all drivers via frequency control, prevents overload, monitors stored trays, and ensures reliable operation. A visual display indicates the device status, while functions are depicted with language. Intuitive icons allow for easy user interaction.





BASIC FUNCTIONALITY AT A GLANCE

- Basic Tray Request & Delivery
- On-Screen Keyboard
- Simple user-friendly GUI
- Updateable
- Remote Assistance
- Simple user training



An intuitive interface for easy picking and storing



WAMAS® LOGIMAT

The software solution for item management with one or multiple VLMs.

WAMAS® LOGIMAT is an ideal solution for one or more VLMs. Depending on the application, the software provides article management and can implement barcode scanners for retrieving or storing items while safely securing inventory at a user level.

WAMAS® LOGIMAT provides warehouse management software (WMS) capabilities. User management, extra security for high-value items, integration of peripheral equipment such as scanners and printers, are just a few of the WAMAS® LOGIMAT features. Storage

strategies such as FIFO and LIFO are supported as well as expiration, lot management, and sell-by dates. The solution is easy to use with simple drag and drop container and tray management tools and includes reporting functions for detailed statistics.

Picking and induction are easy with WAMAS® LOGIMAT. Users can simply induct or pick items with Pick by Light or Put to Light options. In addition, article images are supported, which makes picking and stocking virtually error-free.

CORE FUNCTIONS OF WAMAS® LOGIMAT

- User Management
- Item Management
- Item images
- Location Management (drag & drop bin, tray management)
- Integration of barcode scanners and label printers
- Lot Management
- Best before date
- Storage strategies (incl. FIFO, LIFO)
- Counting function
- Statistics and reports
- Pick by Light
- Put to Light
- Report functions
- Stack processing

BENEFITS OF WAMAS® LOGIMAT

- Streamlined warehouse processes for picking and replenishment
- Simple integration into existing processes
- Virtually error-free picking
- Easy to scale for a future-proof warehouse
- Intuitive user interface with touch panel
- Adds additional security for high-value items
- Basis of WAMAS® LOGIMAT is the worldwide established software WAMAS®
- Best-selling software for SSI LOGIMAT®
- Support for LMB and RK containers (compartmentalization of the containers)
- Supports 3rd Party devices (keyboards, RFID reader, scanner, label printer, etc.)

Order Handling – the solution for order management processing and batch picking.

The Order Handling application is the ideal solution for advanced requirements with a high degree of automation. Based on the functional scope of WAMAS® LOGIMAT, the Order Handling offers an Add-On,

connecting the application to a higher-level ERP system – flexibly via an interface. The advantage: article stocks and orders are automatically synchronized and stored in the ERP or WMS system and in WAMAS® LOGIMAT.

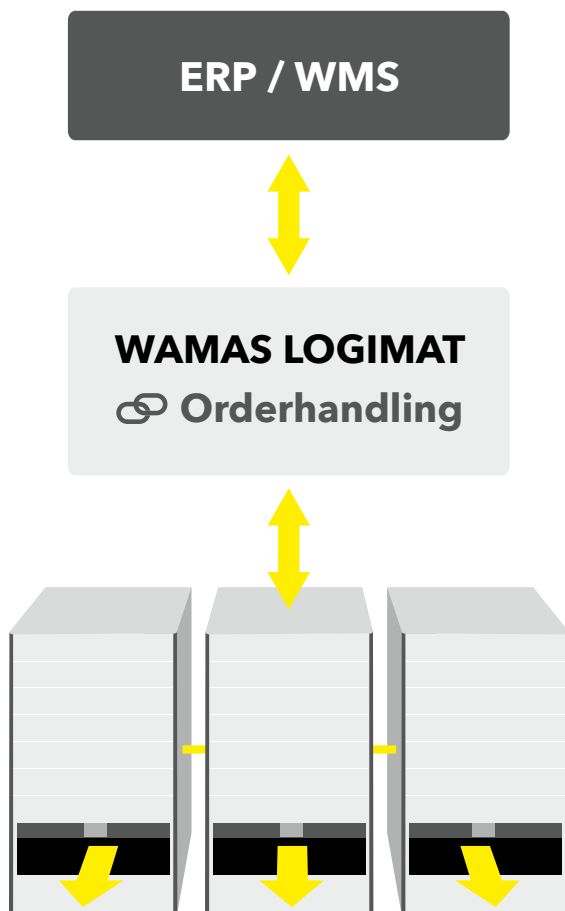

ORDER HANDLING ADD ON OPTIONS

- Order Processing
- Storage, picking and inventory orders
- Flexible interfaces allow simple connection to ERP systems or superordinate warehouse management systems
- Parallel picking to multiple SSI LOGIMAT®
- Order prioritization
- Creation of dynamic picking areas
- Batch picking

BENEFITS

- Consistent user and authorization management
- Order prioritization and handling of express orders
- Configurable strategies for redundant and random warehousing
- Sequence and horizontal optimization



SAP FOR SSI LOGIMAT®

Introducing SPS EasyConnect – all the great features of a VLM with SAP connectivity.

Need continuous stock reliability with real-time collection and accounting through one easy integrated application? SPS EasyConnect incorporates SSI LOGIMAT® into existing SAP warehouse operations. With SPS EasyConnect the master data management, order management and inventory management are conveniently managed in one module. Everything is neatly managed in one complete secure infrastructure with real-time visibility.

SPS EasyConnect makes it simple to plug-and-play an array of functionality. Consistent user and authorization management, order priority and handling of express orders are examples of typical functionality. However, users can take advantage of more complex features as well. Configurable strategies for redundant and/or random warehousing is available. You will also find sequencing optimization and dynamic zoning for assembly processes or kitting applications. Everything you need for a fully managed solution with a global reach.

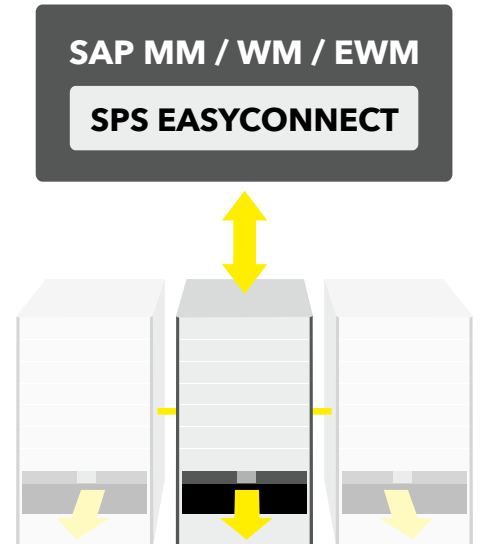

BENEFITS OF THE SSI LOGIMAT® WITH PROCESSING AND SPS EASYCONNECT

- Worldwide leading software system
- No interface risks
- Most commonly used features already included in the standard version
- Comprehensive warehouse management, compatible with the SAP ERP system
- S/4HANA®-Ready
- SSI SCHAEFER provides everything from a single source
- Consistent user and authorization management
- Intuitive, simple operation thanks to step-by-step user guidance
- Order priority and handling of express orders
- Configurable strategies for redundant and random warehousing
- Modular structure of processes and bundling of control functions
- Sequence optimization and horizontal optimization
- Dynamic zoning
- Simple booking of actual quantities and differences via touch
- Variable input manually or by barcode scanning

Get more with plug-and-play functionality

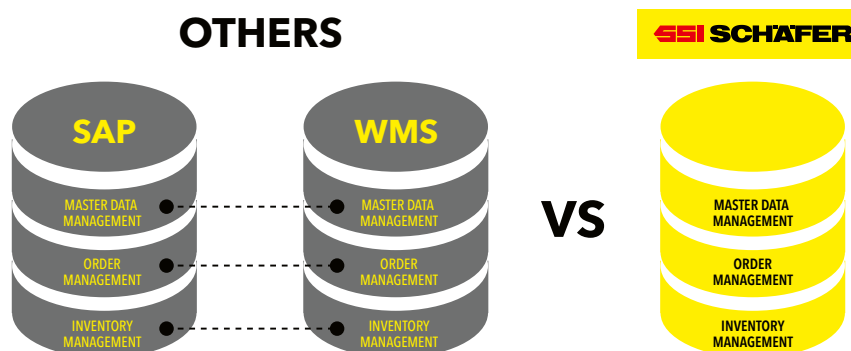



SPS EasyConnect benefits

Simple modular implementation

90% of standard processes allow simple plug-and-play.

SPS EasyConnect Storage

- Manual putaway
- Picking to cost center
- Picking to internal order
- Inventory counting

SPS EasyConnect Tool Management

- Manual putaway
- Manual picking
- Return transfer

SPS EasyConnect Maintenance

- Manual putaway
- Picking to cost center
- Picking to PM order
- Returns from cost center or order

SPS EasyConnect Shipping

- Guided putaway
- Multi-Order-Pick with PTL/pick cart

SPS EasyConnect Production Supply

- Guided putaway
- Kanban supply
- Picking for production order
- Return transfer

3RD PARTY SOFTWARE

Control the SSI LOGIMAT® with your own software.

With the driver interface, the trays can be controlled with the customer's own software. The driver option is an interface based on the TCP/IP protocol. The precise specification can be obtained from our local specialist.

NUMEROUS APPLICATIONS

The SSI LOGIMAT® solution scales as your business grows and is the perfect logistics system for small and medium enterprises and global players.



This application depicts the operating opening of the SSI LOGIMAT® located on the “main level” of the warehouse, which allows the vertical lift module to be built from the basement and span upwards reaching multiple levels

No limits to installation possibilities

With its compact design, the SSI LOGIMAT® vertical lift module fits into virtually any space and meets an array of customer requirements. It accommodates separate storage and retrieval sides, two-sided storage, or retrieval on the floor above, or spanning multiple floors to project through a ceiling, or recessed into the floor.



The SSI SCHAEFER advantage means higher productivity, reliable technologies, flexible applications, and a single source for all components.



Even greater efficiency thanks to conveying systems

Integrating the SSI LOGIMAT® into ergonomically designed conveying systems is an effective measure for maximizing efficient material flow within a facility. The conveying system connects individual warehouse areas or workstations. This allows employees to focus entirely on picking goods from the VLM.



Several SSI LOGIMAT®s can be used for picking and storing items, which allows connectivity of several warehouses



The plastic electroplating specialist GmbH took the path to semi-automation of logistics processes together with SSI SCHAEFER. Three SSI LOGIMAT® Vertical Lift Modules, two automated guided vehicles, type WEASEL® and a short bin conveying system ensure efficient processes between warehouse and production. The warehouse equipment has been designed for expansion.

When C+C Krug contacted SSI SCHAEFER, the new warehouse was under construction. For this reason, it was high time to plan the storage equipment for the new warehouse. The medium-sized company C+C Krug GmbH headquartered in Ottendorf-Okrilla, Saxony, Germany, was founded in 1991 and specializes in plastic electroplating. Sophisticated coating systems are realized from parts construction to sample processing to serial production. C+C Krug produces coating systems for automobile interior and exterior in high gloss as well as customized in matt tones.

The requirements of C+C Krug were communicated to SSI SCHAEFER by using the contact form on the website. "The fast response time of SSI SCHAEFER was unique," says Christian Krause, Head of Logistics at C+C Krug GmbH. "Only one or two days after my inquiry, I got a call from the responsible sales representative and a week later we scheduled an on-site visit."

"We could increase the availability speed by 90%, while picking times were reduced by 50%. In total, we look back at great cooperation with SSI SCHAEFER, communication went extremely well in this cooperation. We plan the next expansion for the near future."



Christian Krause
Head of Logistics
at C+C Krug

Shortly afterwards, the companies were in the projecting phase. For this purpose, the SSI SCHAEFER experts first gained an overview of the number of items and the dimensions of the components, and so determined the overall volume. Among the components on stock at C+C Krug are accent moldings, outer moldings and other design elements to be applied on the inside or outside of cars. Some of the components are bulk goods of approx. 1,000 to 2,000 parts per small load carrier.

Furthermore, the entire processes were monitored and analyzed. Based on time studies, intralogistics emerged as the medium for process optimization. If the raw material did not arrive at the production work station in time, idle times occurred. SSI SCHAEFER presented the customer three different logistics concepts, based on a manual, semi-automated or automated solution. C+C Krug opted for a solution consisting of three SSI LOGIMAT® storage lifts, a bin and carton conveying system, two automated guided vehicles (AGV) type WEASEL and two transfer locations. The warehouse concept has been designed for expansion to be carried out over various construction stages.

IMPRESSIONS ON THE PARTNERSHIP

- Picking times were reduced by 50%
- Shorter distances for employees thanks to high-density storage
- Saving time by switching to the goods-to-person principle
- Increase the availability speed by 90%
- Fast implementation, uncomplicated cooperation
- Personal safe and barrier-free connection of warehouse and production
- The use of space and room is still possible in a flexible manner
- Satisfied employees through ergonomic product design



MULLER MARTINI

As a manufacturer and supplier of systems packed with leading technology, Muller Martini provides services to the global graphics industry. The company develops market-oriented solutions based on their customers' needs. Drawing on decades of experience and a high level of technical expertise, Muller Martini constantly sets new benchmarks with its innovations.

Muller Martini offers high-quality system solutions and first-class services for industrial applications in the graphics industry, with a global sales network and production sites in Switzerland, Germany, the USA, and China.

Muller Martini Print Finishing Systems AG in Zofingen, Switzerland, is the world's leading manufacturer of machinery and systems for print processing and newspaper logistics in the offset and digital printing segment. The systems are developed, manufactured, and marketed in Zofingen.

The company's site in Felben, in the Swiss Canton of Thurgovia, is also a center of excellence for adhesive bonding. Muller Martini Book Technology GmbH in Bad Mergentheim, Germany, is home to the company's Print Finishing Business Unit, where systems for hard cover production are manufactured. The storage of spare

and technology parts as well as the storage of assembly parts has been centralized at the Zofingen site over the last few years. The lift modules which were dismantled at former plants and sites have been re-assembled and consolidated in Zofingen.

Muller Martini knew from experience that storage in lift modules was an optimal solution for their business, which is why the decision was made to strip down the existing, narrow lift modules and replace them with new, innovative SSI LOGIMAT® Vertical Lift Modules from SSI SCHAEFER.

The Zofingen site houses a total of 69,000 materials needed for production, with over half of them stored in the 17 Vertical Lift Modules. With 51,600 storage locations, the Vertical Lift Module installation in Switzerland is the largest of its kind.



„SSI SCHAEFER offered us a complete solution that fully meets our requirements. The SSI LOGIMAT® is a robust product boasting the latest technology and the solution offered for integration into our SAP environment really impressed us.“

Roland Habermann
Head of order logistics, SAL,
OEM purchasing at Muller Martini Print Finishing Systems AG

MÜLLER MARTINI

The spare parts and components handled on a daily basis (approx. 300 different items) are delivered to quality control, or are taken directly to the assembly area or warehouse, depending on the requirements. An incoming goods transaction and a transport order are generated via ERP (SAP) for those parts that are delivered straight to the warehouse. The goods are then transported to the SSI LOGIMAT®s for storage with the accompanying documentation.

If an assembly order is planned and recorded in the ERP system, a picking order is generated and provided to the employees. The barcode printed on the picking order is read by the barcode scanner on the SSI LOGIMAT®. The required components are now provided by the SSI LOGIMAT®. Every time an item is removed, the process is acknowledged using the LogiBar. The lift system needs to generate the retrieval process for the parts in ascending order by storage location and SSI LOGIMAT® to ensure efficient picking.

THE PROJECT GOALS

- Provision of a 2,600 m² storage area for approx. 48,000 items
- Dismantling of the existing lift modules and construction of SSI LOGIMAT® without disrupting normal plant operation
- Integration of Vertical Lift Modules into the SAP environment by SPS EasyConnect

Once the order has been fully picked, the components, which are gathered on a carousel carrier, are sent for removal in the relevant area. The goods are then delivered via internal transport to the previously defined assembly address, where the parts are installed accordingly.





SERVICE & MAINTENANCE

Making sure everything runs smoothly.

If you choose SSI SCHAEFER, you can also rely on our strengths in the servicing sector that have made us a market leader: A range of services that is unique in this sector and the certainty that all services and site visits will be carried out by our own specialized service technicians. Thanks to its robust design and high-quality components, the SSI LOGIMAT® is extremely low-maintenance.

With customer-specific servicing and maintenance models, as well as innovative spare parts concepts, our global Customer Service & Support team ensures the optimal availability of your system, maximum operational reliability, and complete customer satisfaction.



OUR SERVICES

- On-site troubleshooting
- Preventative maintenance
- Constant system monitoring
- Regular inspections and safety checks
- Global spare parts service
- Full documentation
- Analysis capability
- Targeted training courses and certification
- Individually tailored modernization measures



SIX REASONS FOR CHOOSING SSI SCHAEFER

- **Stability**

As a financially independent family business, SSI SCHAEFER is committed to long-term solutions. You can trust that our team of experts will be there for you today, tomorrow and in years to come.

- **Efficiency**

SSI SCHAEFER solutions are scalable and able to grow with your business. You can always upgrade or retrofit.

- **Quality**

As a systems specialist and original equipment manufacturer, SSI SCHAEFER provides tailor-made and high-quality solutions from a single source, specifically designed to meet your challenges.

- **Reliability**

Thanks to our worldwide Customer Service & Support network, SSI SCHAEFER ensures smooth operation of your system, both during and after installation.

- **Know-how**

SSI SCHAEFER solutions are always up-to-date with the latest technological standards and can be easily integrated into an existing (IT) landscape.

- **Internationality**

As a global organization, SSI SCHAEFER has local offices worldwide. With over 70 operative subsidiaries, our team of experts speak your language.

[ssi-schaefer.com](https://www.ssi-schaefer.com)

02/2021 EN © SSI SCHAEFER
No liability for printing errors.

SSI SCHAEFER